





			±	

	JC		
	JA		



					±	

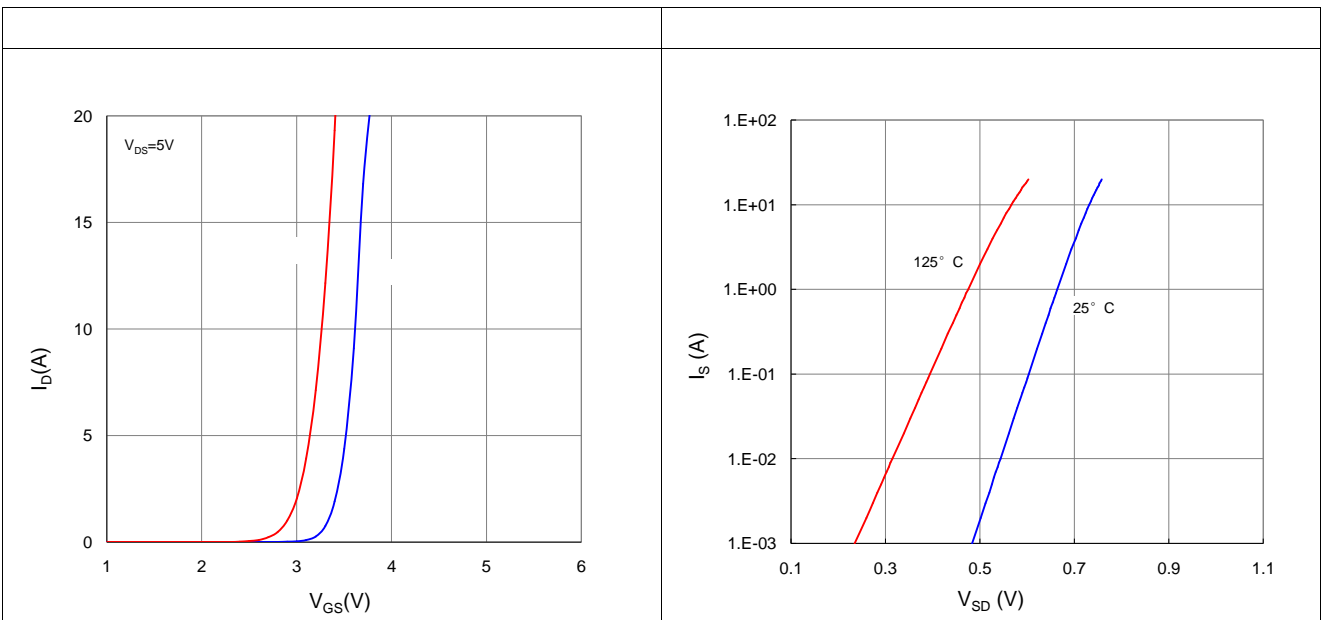
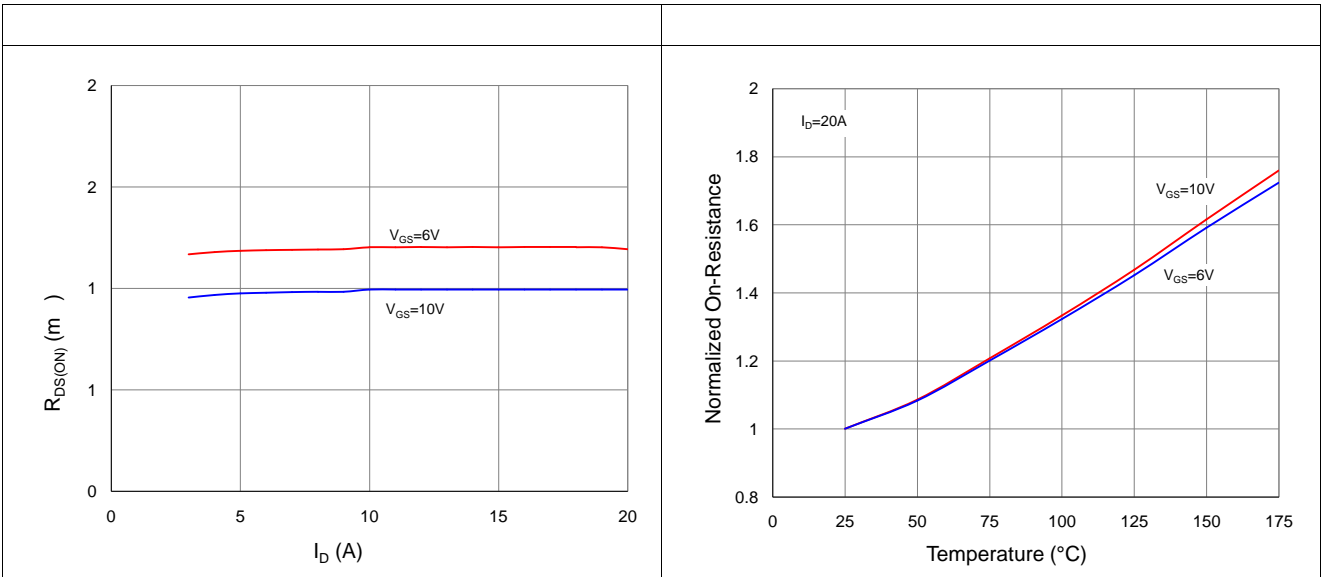
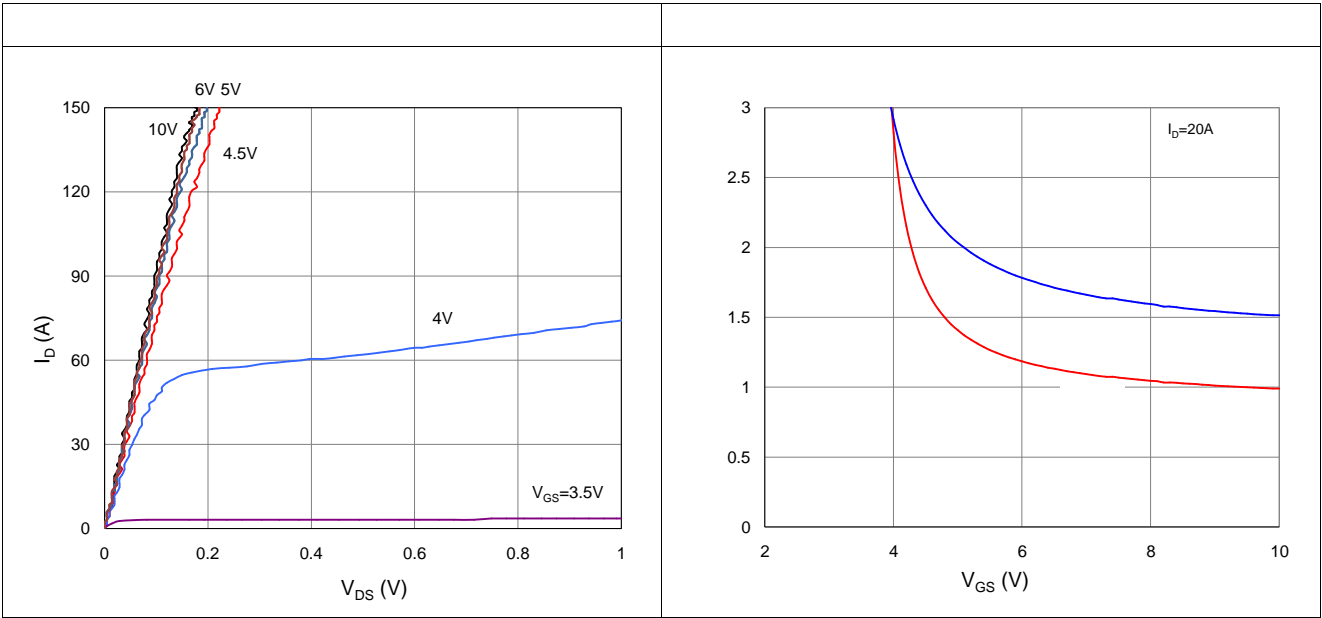

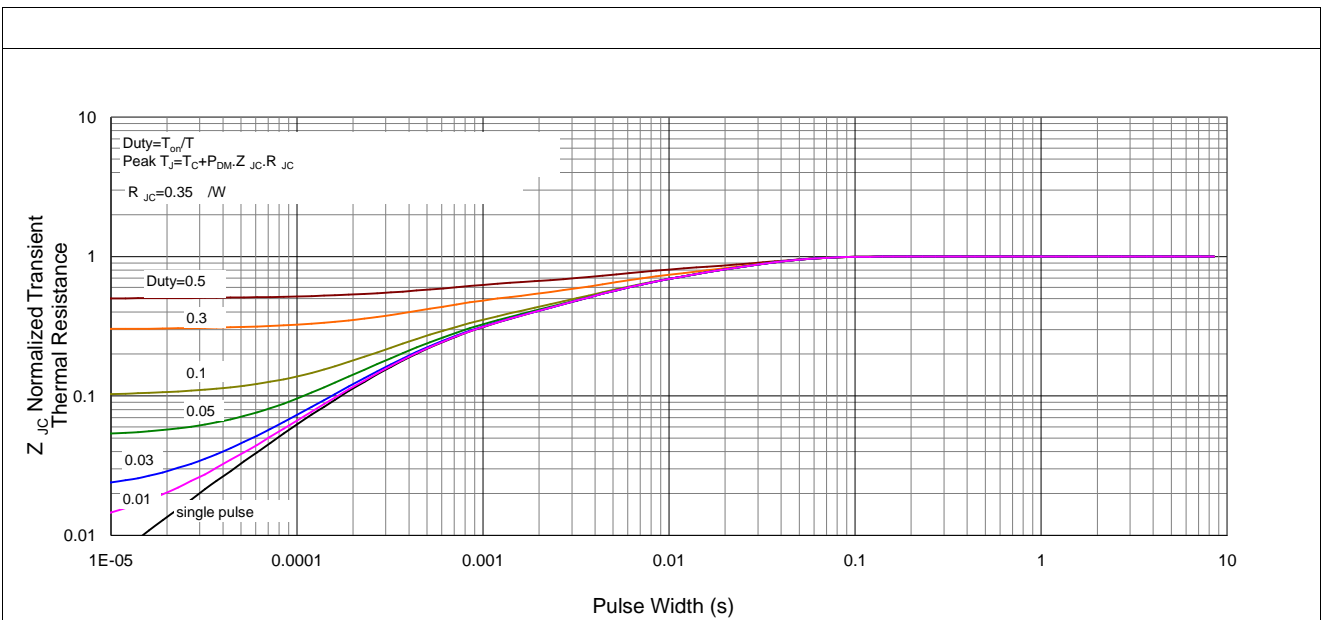
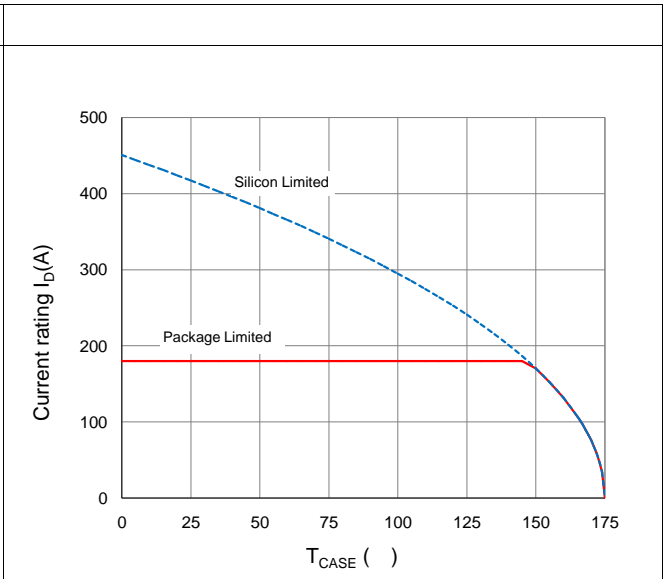
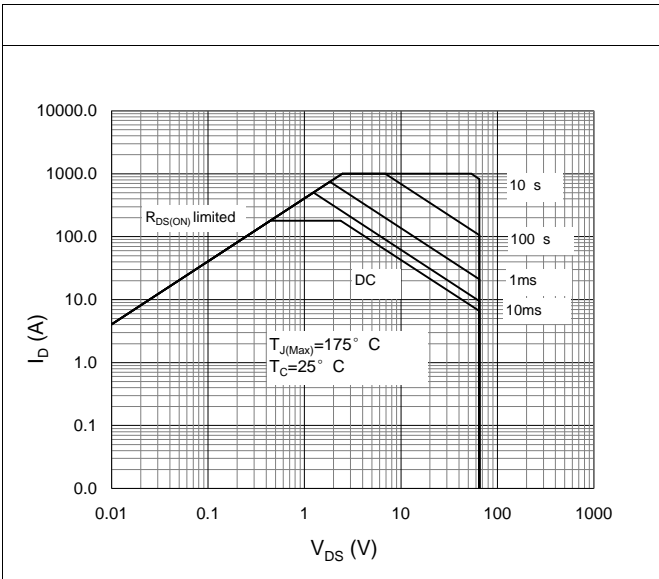
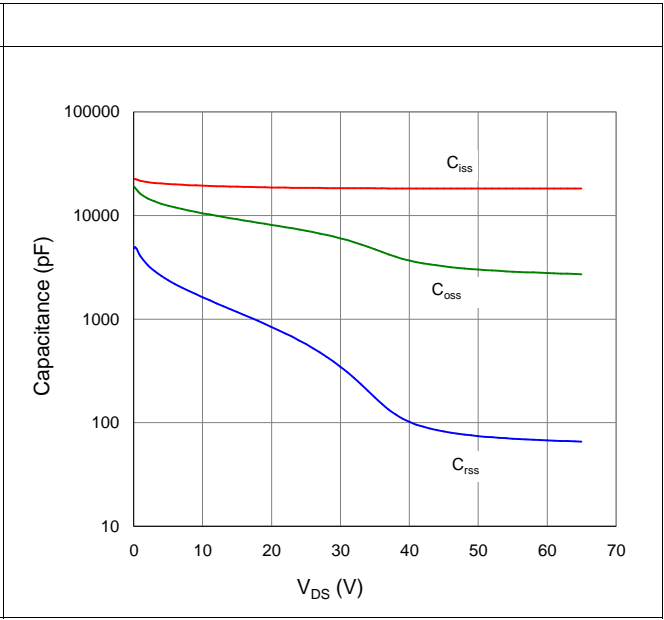
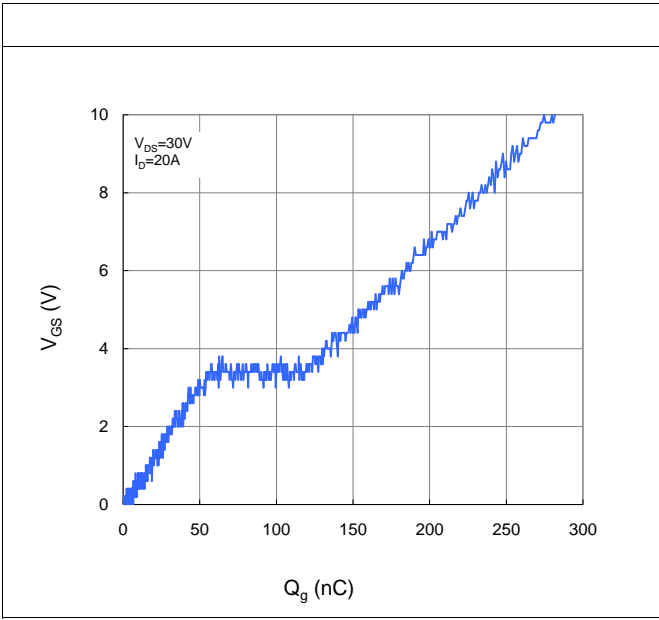



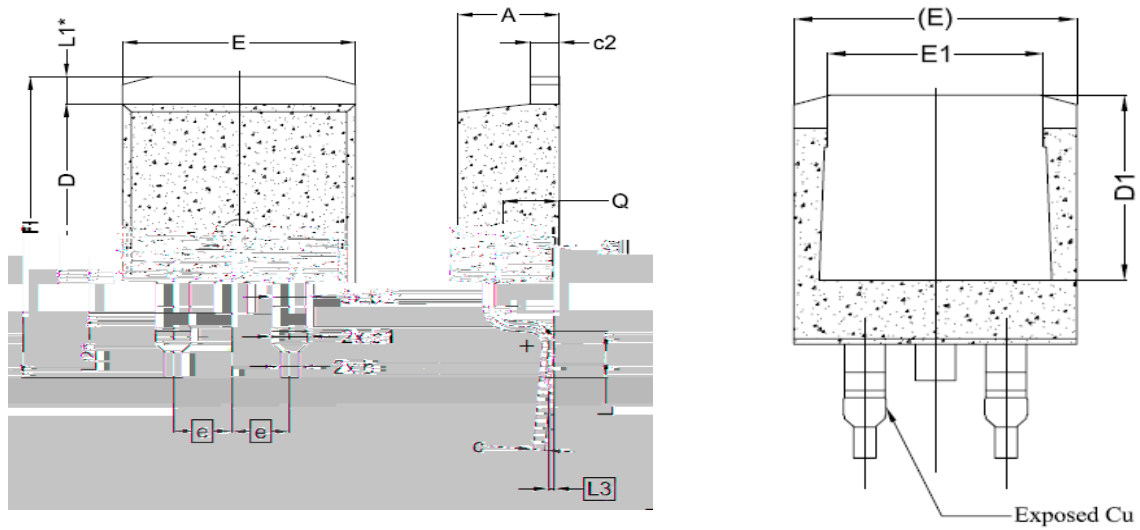

SYMBOL	DIMENSIONS		
	MIN.	NOM.	MAX.
A	4,24	4,44	4,64
A1	0,00	0,10	0,25
b	0,70	0,80	0,90
b1	1,20	1,55	1,75
b2	1,20	1,45	1,70
c	0,40	0,50	0,60
c2	1,15	1,27	1,40
D	8,82	8,92	9,02
H	6,86	7,65	

E	8,82	9,02
E1	8,82	9,02
e		2,54
H	14,61	15,30
L	1,78	2,32
L1		1,25 REF
L2		1,50 REF
L3		0,25 BSC
Q	2,30	2,48

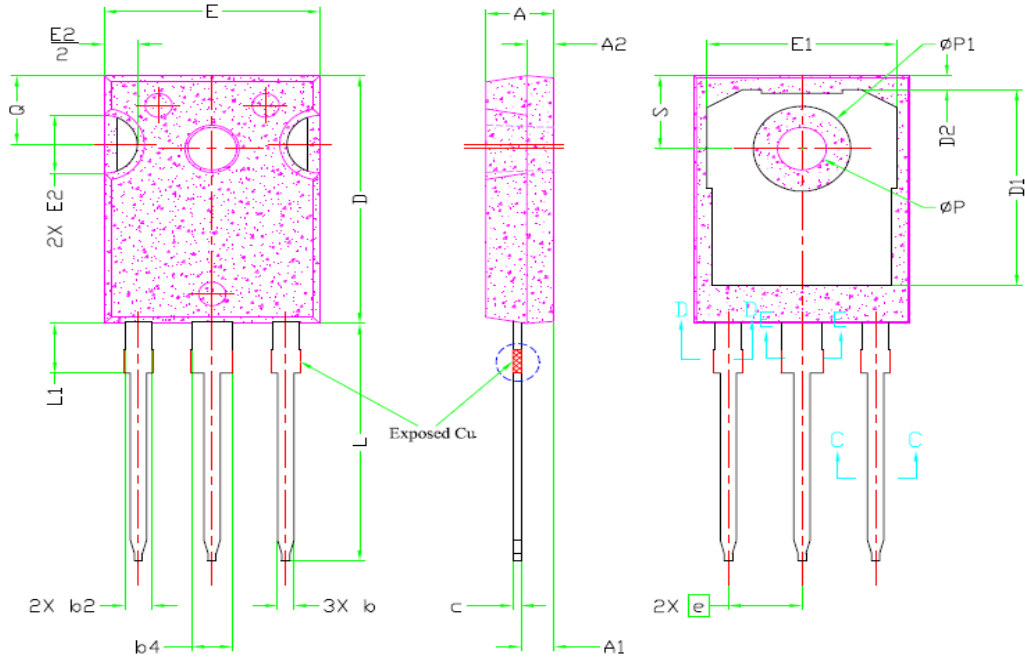

SYMBOL	DIMENSIONS			NOTES
	MIN.	NOM.	MAX.	
A	10.00	10.00	5.24	
A1	10.00	10.00	5.24	
A2	10.00	10.00	5.24	
b	0.50	0.50	0.50	
b2	0.50	0.50	0.50	
b4	0.50	0.50	0.50	
c	0.50	0.50	0.50	
D	10.00	10.00	10.00	
D1	10.00	10.00	10.00	
D2	10.00	10.00	10.00	
E	10.00	10.00	10.00	
E1	10.00	10.00	10.00	
E2	10.00	10.00	10.00	
L	10.00	10.00	10.00	
L1	10.00	10.00	10.00	
L2	10.00	10.00	10.00	
L3	10.00	10.00	10.00	
L4	10.00	10.00	10.00	
L5	10.00	10.00	10.00	
L6	10.00	10.00	10.00	
L7	10.00	10.00	10.00	
L8	10.00	10.00	10.00	
L9	10.00	10.00	10.00	
L10	10.00	10.00	10.00	
L11	10.00	10.00	10.00	
L12	10.00	10.00	10.00	
L13	10.00	10.00	10.00	
L14	10.00	10.00	10.00	
L15	10.00	10.00	10.00	
L16	10.00	10.00	10.00	
L17	10.00	10.00	10.00	
L18	10.00	10.00	10.00	
L19	10.00	10.00	10.00	
L20	10.00	10.00	10.00	
L21	10.00	10.00	10.00	
L22	10.00	10.00	10.00	
L23	10.00	10.00	10.00	
L24	10.00	10.00	10.00	
L25	10.00	10.00	10.00	
L26	10.00	10.00	10.00	
L27	10.00	10.00	10.00	
L28	10.00	10.00	10.00	
L29	10.00	10.00	10.00	
L30	10.00	10.00	10.00	
L31	10.00	10.00	10.00	
L32	10.00	10.00	10.00	
L33	10.00	10.00	10.00	
L34	10.00	10.00	10.00	
L35	10.00	10.00	10.00	
L36	10.00	10.00	10.00	
L37	10.00	10.00	10.00	
L38	10.00	10.00	10.00	
L39	10.00	10.00	10.00	
L40	10.00	10.00	10.00	
L41	10.00	10.00	10.00	
L42	10.00	10.00	10.00	
L43	10.00	10.00	10.00	
L44	10.00	10.00	10.00	
L45	10.00	10.00	10.00	
L46	10.00	10.00	10.00	
L47	10.00	10.00	10.00	
L48	10.00	10.00	10.00	
L49	10.00	10.00	10.00	
L50	10.00	10.00	10.00	